



FWQ128/2025/2026

SUPPLY AND DELIVERY OF FILTER NOZZLES

CLOSING DATE: 6 FEBRUARY 2026	CLOSING TIME: 12h00
--------------------------------------	----------------------------

NAME OF BIDDER*	
TRADING NAME*	
ADDRESS*	
TELEPHONE NUMBER*	
CELLPHONE NUMBER*	
E-MAIL ADDRESS*	
CENTRAL SUPPLIER DATABASE REGISTRATION NR*	
B-BBEE LEVEL OF CONTRIBUTION*	
LOCALITY (Municipal Area/Province where Business is Located) *	
TENDER AMOUNT (VAT included) *	

(* - TO BE COMPLETED BY BIDDER)

Prepared by:
Mossel Bay Municipality
PO Box 25
Mossel Bay
6500

INDEX

SECTION 1		PAGE nr
1.1	INVITATION TO QUOTE	3
1.2	CONDITIONS AND INFORMATION	4
1.3	SPECIAL CONDITIONS OF CONTRACT	12
SECTION 2		
2.1	SPECIFICATIONS	14
2.2	PRICING SCHEDULE	18
SECTION 3		
3.1	MBD1: BID REQUIREMENTS OF THE MOSSEL BAY MUNICIPALITY	19
SECTION 4		
4.1	MBD4: DECLARATION OF INTEREST	22
4.2	MBD6.1: PREFERENCE POINTS CLAIM FORM IN TERMS OF THE PREFERENTIAL PROCUREMENT REGULATIONS, 2022	25
4.3	MUNICIPAL RATES AND TAXES	30
4.4	AUTHORISED SIGNATORY	31
4.5	MBD8: DECLARATION OF BIDDER'S PAST SUPPLY CHAIN MANAGEMENT PRACTICES	32
4.6	MBD9: CERTIFICATE OF INDEPENDENT BID DETERMINATION	34
SECTION 5	DECLARATION	37
SECTION 6	CONTRACT FORM	38

SECTION 1.1: INVITATION TO QUOTE

CLOSING TIME: 12h00

CLOSING DATE: 6 FEBRUARY 2026

FWQ128/2025/2026: SUPPLY AND DELIVERY OF FILTER NOZZLES

Formal written quotations are hereby invited from service providers for the supply and delivery of filter nozzles for the Department of Infrastructure services.

Formal written quotations must be submitted on the original documents and remain valid for ninety (90) days after the closing date of the quote. Enquiries pertaining to the specifications can be addressed to Mr. Benjamin Dido at telephone (044) 606-5000 (ext.6512) or e-mail at bdido@mosselbay.gov.za. Enquiries pertaining to the completion of the documents can be addressed to Mr. E Chandler at telephone (044) 606-5196 or e-mail at echandler@mosselbay.gov.za.

A set of formal written quotation documents can be obtained at a non-refundable cost of R132,00 per set from Ms. C Muller who may be contacted at telephone (044) 606-5000 or e-mail at cmuller@mosselbay.gov.za OR it can be obtained on our website at www.mosselbay.gov.za free of charge. If you require a hard copy of the formal written quotation document, payments must be made at the cashiers at the **Mossel Bay Municipality's Main Building, 101 Marsh Street on the Lower Ground Floor (seaside) or EFT(Banking details and Reference Nr can be obtained from esnyders@mosselbay.gov.za)**, prior to collecting and proof of payment must be provided when collecting the formal written quotation document from the Supply Chain Management Offices, 101 Marsh Street, Mossel Bay.

Fully completed formal written quotation documents must be placed in a sealed envelope and placed in the **tender box at the Entrance of the Mossel Bay Town Hall, 101 Marsh Street, Mossel Bay by not later than 12h00 on Friday, 6 February 2026** or be courier to reach the **Tender Box, Mossel Bay Municipality** before the specified closing date and time. The envelopes must be endorsed clearly with the number, title and closing date of the tender as above.

Responsive bids will be evaluated on the 80/20 Preference Points System. A maximum of 20 points (80/20 preference point system) will be allocated for specific goals. 50% of the 20 points will be allocated in terms of a bidder's B-BBEE scorecard and other 50% of the 20 points will be for a bidder's locality.

The tender box will be emptied just after 12h00 on the closing date as above, hereafter all bids will be opened in public. Late formal written quotations or formal written quotations submitted by e-mail or fax will under no circumstances be accepted.

The Municipality reserves the right to withdraw any invitation of a formal written quotation and/or to re-advertise or to reject any formal written quotation or to accept a part of it. The Municipality does not bind itself to accepting the lowest formal written quotation or award a contract to the bidder scoring the highest number of points.

It is expected of all Bidders who are not yet registered on the Central Supplier Database to register without delay on the prescribed form. The Municipality reserves the right not to award formal written quotations to Bidders who are not registered on this Database.

....

**MR C PUREN
MUNICIPAL MANAGER**

SECTION 1.2: CONDITIONS AND INFORMATION

1.2.1 General and Special Conditions of Contract

The General Conditions of Contract (GCC) available on the National Treasury website <http://www.treasury.gov.za/divisions/ocpo/sc/GeneralConditions/> will be applicable to this formal written quotation as well as Special Conditions of Contract (SCC) (if applicable) forming part of this set of quotation documents in addition to the conditions and information. Where the GCC and SCC are in conflict with one another, the stipulations of the SCC will prevail. Please ensure that note is taken of the content of the GCC.

1.2.2 Acceptance or Rejection of a Quote

The Municipality reserves the right to withdraw any invitation to quote and/or to re-advertise or to reject any quote or to accept a part of it. The Municipality does not bind itself to accepting the lowest quote or the quote scoring the highest points.

1.2.3 Validity Period

Bids shall remain valid for ninety (90) days after the tender closure date.

1.2.4 Cost of Bid Documents

A set of quotation documents can be obtained at a non-refundable cost of R132.00 per set from Ms. Candy Muller who may be contacted at telephone (044) 606-5000 ext.6188 or e-mail at cmuller@mosselbay.gov.za **OR** it can be obtained on our website at www.mosselbay.gov.za free of charge. If you require a hard copy of the bid document, payments must be made at the cashiers at the **Mossel Bay Municipality's Main Building, 101 Marsh Street on the Lower Ground Floor (seaside) or EFT (Banking details and Reference Nr can be obtained from esnyders@mosselbay.gov.za)**, prior to collecting and proof of payment must be provided when collecting the bid document from the Supply Chain Management Offices, 101 Marsh Street, Mossel Bay.

1.2.5 Registration on the Central Supplier Database

It is expected of all prospective service providers who are not yet registered on the Central Supplier Database to register without delay on the prescribed form. The Municipality reserves the right not to award quotations to prospective suppliers who are not registered on this Database.

1.2.6 Completion of Bid Documents

- (a) The original bid document must be fully completed and originally signed in black ink and signed by the authorised signatory to validate the quote. Section 5: DECLARATION must be completed and signed by the authorised signatory and returned. Failure to do so will result in the disqualification of the quote and will not be evaluated. NO ELECTRONIC SIGNATURES IS ALLOWED.
- (b) Bid documents may not be retyped. Retyped documents will result in the disqualification of the quotation and will not be evaluated.
- (c) The complete original bid document must be returned. Material pages that are omitted from the tender document may result in the disqualification of the tender and the bidder will not be evaluated. The Municipality reserves the right to request immaterial pages that were omitted.

- (d) No unauthorised alteration of this set of bid documents will be allowed. Any unauthorised alteration will disqualify the quotation automatically. Any ambiguity has to be cleared with contact person for the quotation before the quotation closure.
- (e) The bid document as provided by the Municipality's Supply Chain Management Section will be the prevailing document in the event of an inconsistency between the completed submitted bid document by a bidder and the bid quotation document provided by the Municipality.

1.2.7 Compulsory Documentation

1.2.7.1 Tax Clearance Certificate

- (a) A copy of a Tax Compliance Status Pin, printed from the South African Revenue Service (SARS) website, must accompany the bid documents. The onus is on the bidder to ensure that their tax matters with SARS are in order.
- (b) In the case of a Consortium/Joint Venture every member must submit a separate Tax Compliance Status Pin, printed from the SARS website, with the bid documents.
- (c) If a bid is not supported by a Tax Compliance Status Pin as an attachment to the bid documents, the Municipality reserves the right to obtain such documents after the closing date to verify that the bidder's tax matters are in order. If no such document can be obtained within a period as specified by the Municipality, the bid will be disqualified.
- (d) The Tax Compliance Status Pin will be verified by the Municipality on the SARS website.

1.2.8 Other Documentation

1.2.8.1 Construction Industry Development Board (CIDB) (If applicable)

- (a) When applicable, the bidder's CIDB registration number must be included with the tender. The Municipality will verify the bidder's CIDB registration during the evaluation process.
- (b) A bidder will be non-responsive, if the CIDB status of the bidder indicates suspended or inactive or deregistered on the day of evaluation.

1.2.8.2 Municipal Rates, Taxes and Charges

- (a) A copy of the bidder's and those of its director's/members municipal accounts (for the Municipality where the bidder and its director's/members pay their account) for the month preceding the quotation closure date must accompany the bid documents. If such a copy does not accompany the bid document of the successful bidder, the Municipality reserves the right to obtain such documents after the closing date to verify that their municipal accounts are in order.
- (b) Any bidder which is or whose directors are in arrears with their municipal rates and taxes or municipal charges due to any Municipality or any of its entities for more than three months and have not made an

arrangement for settlement of same before the bid closure date will be unsuccessful. The arrangement for settlement for the outstanding amount (which were done before the closing date of the bid), must also be submitted with the bid document.

- (c) If a bidder and its director's/members rent their premises, the current lease agreement must be submitted with the bid document, which indicates that the rental includes their municipal rates and taxes. If the lease agreement indicates that the bidder or its director's/members are responsible to pay the municipal rates and taxes, the Municipal Account of the leased premises indicated must also be submitted.
- (d) If a bidder and its director's/members, do not own any property, they must submit the following:
 - (i) Affidavit from the bidder and its director's/members, that they do not own any property;
 - (ii) Affidavit from the owner of the property where business is situated/director's/members reside, that the bidder and its director's/members are not liable for the municipal rates and taxes.
- (e) If a bidder and its director's/members, lives outside of South Africa, an affidavit must be submitted.
- (f) If a bidder or its director's/members, lives outside of South Africa, an affidavit must be submitted by the Company.

1.2.9 Authorised Signatory

- (a) A copy of the recorded Resolution taken by the Board of Directors, members, partners or trustees authorising the representative to submit this bid on the bidder's behalf must be attached to the Bid Document on submission of same.
- (b) A bid shall be eligible for consideration only if it bears the signature of the bidder or of some person duly and lawfully authorised to sign it for and on behalf of the bidder.
- (c) If such a copy of the Resolution does not accompany the bid document of the successful bidder, the Municipality reserves the right to obtain such document after the closing date to verify that the signatory is in order. If no such document can be obtained within a period as specified by the Municipality, the bid will be disqualified and will not be evaluated.
- (d) If a bidder is a sole proprietor, no such documentation is required, provided that the document was completed and signed by the owner.

1.2.10 Site / Information Meetings

- (a) Site or information meetings, if specified (in the advert), are **compulsory**. Bids will not be accepted from bidders who have not attended the compulsory site or information or online briefing meetings. Bidders that arrive or log in 15 minutes or more after the advertised time the meeting starts will not be allowed to attend the meeting or to sign the attendance register. If a bidder is delayed/have connection problems, he/she must inform the contact person before the meeting commence and will only be allowed to attend the meeting if the chairperson of the meeting as well as all the other bidders attending the meeting, give permission to do so.
- (b) All bidders, including **ALL THE PARTNERS OF A JOINT VENTURE** must attend the compulsory site or information or online briefing meeting.

1.2.11 Samples

Samples, if requested, are to be provided to the Municipality with the bid document or as stipulated.

1.2.12 Quantities of Specific Items

If tenders are called for a specific number of items, the Municipality reserves the right to change the number of such items to be higher/more or lower/less. If the successful bidder does not accept the new scenario, it will be offered to the second-placed bidder.

1.2.13 Submission of Tender

(a) The tender must be placed in a sealed envelope, or envelopes when the two-envelope system is specified, clearly marked with the tender number, title as well as closing date and time and placed in the **tender box at the Entrance of the Mossel Bay Town Hall, 101 Marsh Street, Mossel Bay Municipality by not later than 12h00 on Friday, 6 February 2026.**

OR

(b) Faxed, e-mailed and late tenders will not be accepted. Tenders may be delivered by hand, by courier, at the bidder's risk and must be received by the deadline specified above, irrespective of how they are sent or delivered.

1.2.14 Expenses Incurred in Preparation of Tender

The Municipality shall not be liable for any expenses incurred in the preparation and submission of the tender.

1.2.15 Contact with Municipality after Tender Closure Date

Bidders shall not contact the Mossel Bay Municipality on any matter relating to their bid from the time of the opening of the bid to the time the contract is awarded. If a bidder wishes to bring additional information to the attention of the Mossel Bay Municipality, it should do so in writing to the Supply Chain Management Department of the Mossel Bay Municipality. Any effort made by the firm to influence the Mossel Bay Municipality or any official in evaluation of the bid, bid comparison or contract award decisions may result in the rejection of the bid and further action being taken.

1.2.16 Opening, Recording and Publications of Tenders Received

(a) Tenders will be opened on the closing date immediately after the closing time specified in the bid documents. If requested by any bidder present, the names of the bidders, and if practical, the total amount of each bid and of any alternative offers will be read out aloud.

(b) Details of tenders received in time will be recorded in a register which is open to public inspection.

1.2.17 Evaluation of Tenders

Tenders will be evaluated in terms of their responsiveness to the tender specifications and requirements as well as such additional criteria as set out in this set of bid documents.

1.2.18 Procurement Policy

Bids will be awarded in accordance with the Preferential Procurement Regulations, 2022 pertaining to the Preferential Procurement Policy Framework Act, No 5 of 2000 and its amendments as well as the Municipality's Supply Chain Management and the current Municipal Preferential Procurement Policy.

1.2.19 Contract

The successful bidder will be expected to sign the agreement in Section 6 of this bid document. The signing of both Parts of Section 6 of this bid document signifies the conclusion of the contract. The Municipality, at its discretion, may request the signing of an additional Service Level Agreement which, together with the signed bid document, will constitute the full agreement between the Municipality and the successful bidder.

1.2.20 Subcontracting

- (a) The Contractor shall not subcontract the whole of the Contract.
- (b) Except where otherwise provided by the Contract, the Contractor shall not subcontract any part of the Contract without the prior written consent of the Municipality, which consent shall not be unreasonably withheld.
- (c) The contractual relationship between the Contractor and any subcontractors selected by the Contractor in consultation with the Municipality in accordance with the requirements of and a procedure contained within the Scope of Work, shall be the same as if the Contractor had appointed the subcontractor in terms of paragraph (b) above.
- (d) Any consent granted in accordance with paragraph (b) or appointment of a subcontractor in accordance with paragraph (c) shall not imply a contract between the Municipality and the subcontractor, or a responsibility or liability on the part of the Municipality to the subcontractor and shall not relieve the Contractor from any liability or obligation under the Contract and he shall be liable for the acts, defaults and neglects of any subcontractor, his agents or employees as fully as if they were the acts, defaults or neglects of the Contractor, his agents or employees.
- (e) The Contractor shall not be required to obtain such consent for –
 - (i) the provision of labour, or
 - (ii) the purchase of materials which are in accordance with the Contract, or
 - (iii) the purchase or hire of Construction Equipment.

1.2.21 Language of Contract

The contract documents will be compiled in English and the English versions of all referred documents will be taken as applicable.

1.2.22 Extension of Contract

The Municipality reserves the right to negotiate the extension or expansion of a contract with the successful bidder should additional funds become available. This prescribed process in terms of legislation must be followed prior to any agreement being concluded and the vesting of any rights.

1.2.23 Stamp and Other Duties

The successful bidder will be liable for all duties and costs on legal documents resulting in the establishment of a contract and for the surety, guarantees and retentions.

1.2.24 Wrong Information Furnished

Where a contract has been awarded on the strength of the information furnished by the bidder which, after the conclusion of the relevant agreement, is proved to have been incorrect, the Municipality may, in addition to any other legal remedy it may have, recover from the contractor all costs, losses or damages incurred or sustained by the Municipality as a result of the award of the contract.

1.2.25 Past Practices

- (a) The bid of any bidder may be rejected if that bidder or any of its directors, principle shareholders or members have abused the municipality's supply chain management system or committed any improper conduct in relation to such system.
- (b) The bid of any bidder may be rejected if it is or has been found that that bidder or any of its directors, principle shareholders or members influenced or tried to influence any official or councillor with this or any past tender.
- (c) The bid of any bidder may be rejected if it is or has been found that that bidder or any of its directors, principle shareholders or members offered, promised or granted any official or any of his/her close family members, partners or associates any reward, gift, favour, hospitality or any other benefit in any improper way, with this or any past tender.

1.2.26 DOCUMENTATION REQUIRED TO CLAIM POINTS FOR SPECIFIC GOALS

1.2.26.1 Proof of B-BBEE Status Level of Contributor:

- (a) A sworn affidavit as prescribed by the B-BBEE Codes of Good Practice; or
- (b) Any other requirement prescribed in terms of the Broad-Based Black Economic Empowerment Act, as indicated below:

- **If the certificate was issued by a verification agency the following must be on the face of the certificate:**

SANAS logo, unique BVA number, must be an original certificate or certified copy of the original, the name and physical location of the bidder, the registration number and, where applicable, the VAT number of the bidder, the date of issue and date of expiry of the certificate, the certificate number for identification and reference, the scorecard that was used (for example EME, QSE or Generic), the name and / or logo of the

Verification Agency, the certificate must be signed by the authorized person from the Verification Agency and the B-BBEE Status Level of Contribution obtained by the bidder.

- **If certificate was issued by an Auditor/ Accounting Officers:**

The Accounting Officer's or Registered Auditor's letter head with full contact details, the Accounting Officer's or Registered Auditor's practice numbers, the name and the physical location of the bidder, the registration number and, where applicable, the VAT number of the bidder, the date of issue and date of expiry, the B-BBEE Status Level of Contribution obtained by the measured entity, the total black shareholding and total black female shareholding, the B-BBEE Status Level of Contribution obtained by the bidder and must be an original certificate or certified copy of the original.

- **If the certificate was issued by registered auditors approved by IRBA**

Clearly identify the B-BBEE approved registered auditor by the auditor's individual registration number with IRBA and the auditor's logo, clearly record an approved B-BBEE Verification Certificate identification reference in the format required by the SASAE, reflect relevant information regarding the identity and location of the measured entity, identify the Codes of Good Practice or relevant Sector Codes applied in the determination of the scores, record the weighting points (scores) attained by the measured entity for each scorecard element, where applicable, and the measured entity's overall B-BBEE Status Level of Contribution, reflect that the B-BBEE Verification Certificate and accompanying assurance report issued to the measured entity is valid for 12 months from the date of issuance and reflect both the issuance and expiry date, and the B-BBEE Status Level of Contribution obtained by the bidder and must be an original certificate or certified copy of the original.

1.2.26.2 Proof of Locality in a Specific Province, Region and Municipal Area

- (a) Points for specific goals to promote suppliers or service providers located in a province, district or municipal area / (hereafter referred to as locality).
- (b) Each tender must specify in the invitation to tender that a maximum of 50% of the 20/10 points will be allocated to promote the specific goal of locality.
- (c) Only one of the points as set out below that best describes the enterprise's locality may be awarded if applicable.

No	Requirement	Points for enterprises within Mossel Bay municipal area	Points for enterprises within Garden Route District region	Points for enterprises within the Western Cape Province and other Provinces
1	Procurement under the 80/20 preference points system where the supplier or service provider is located in:	10	6	4

- (d) Bidders must submit one of the following in order to receive points for the abovementioned criterion.
 - (i) Municipal Account of bidder's address as indicated in bid document;

- (ii) If the address as indicated in bid document is not in the name of the bidder, the latest lease agreement for this address or sworn affidavit from the registered owner of the property stating occupancy by the bidder is required.
- (iii) The business address of the bidder as indicated in the MBD6.1 of the bid document as the business premises should be established/leased prior to the advertisement date.
- (iv) In instances below R30 000 the address as specified within the Central Supplier Database will be utilized for identification of the specific goal and the points will automatically be added to the preference point system. The Municipality however reserves the right to also request supporting evidence.
- (v) Only fully operational business premises will be accepted. All vacant erven, storage units and postal addresses do not qualify as a business premises.

1.2.27 Negotiations

Should the tender prices be higher than the available funds of the client, the client reserves the right to negotiate with the successful bidder to limit the work in accordance with the tender specifications in order not to exceed the available budget. These negotiations can be done prior or after the final award.

1.2.28 Enquiries

Enquiries in connection with this tender, prior to the tender closure date, may be addressed to Mr. Benjamin Dido at telephone (044) 606-5000 (ext.6512) or e-mail at bdido@mosselbay.gov.za.

oooOOOooo

1.3 SPECIAL CONDITIONS

- (a) In the event of Non- or Poor Performance of Service Providers/Suppliers, it will be dealt with in terms of Section 43 of the SCM Policy.
- (b) Penalties services/items will be done will be dealt with in terms of section 22 of the General Conditions of Contract as stated below. Also refer to paragraph 1.1.2, Section 1.2: Conditions and Information.

“22. Penalties

22.1 Subject to GCC clause 25, if the supplier fails to deliver any or all of the goods or to perform the services within the period(s) specified in the contract, the purchaser shall, without prejudice to its other remedies under the contract, deduct from the contract price, as a penalty, a sum calculated on the delivered price of the delayed goods or unperformed services using the current prime interest rate calculated for each day of the delay until actual delivery or performance. The purchaser may also consider termination of the contract pursuant to GCC clause 23.”

- (c) A preferred and alternative bidder may be appointed depending on the responsiveness of bidders.
- (d) The successful bidder (preferred bidder) must confirm, in writing, within 24 hours after receipt of the order, that the required quantity per order can be delivered. Failure to respond or to make alternative arrangements with the relevant municipal official will result in cancellation of the order and the first alternative bidder will be used.
- (e) The first alternative bidder must confirm, in writing, within 24 hours after receipt of the order, that the required quantity per order can be delivered. Failure to respond or to make alternative arrangements with the relevant municipal official will result in cancellation of the order and it will be deemed that the items cannot be delivered, and then three (3) quotations and/or other relevant procurement process will be followed.
- (f) The second alternative bidder must confirm, in writing, within 24 hours after receipt of the order, that the required quantity per order can be delivered. Failure to respond or to make alternative arrangements with the relevant municipal official will result in cancellation of the order and will be deemed that the items cannot be delivered, and then three (3) quotations and/or formal written quotations (FWQ) process will be followed.
- (g) Payment of services/items will be dealt with in terms of section 16 of the General Conditions of Contract as stated below:

“16. Payment

- 16.1 The method and conditions of payment to be made to the supplier under this contract shall be specified.
- 16.2 The supplier shall furnish the purchaser with an invoice accompanied by a copy of the delivery note and upon fulfilment of other obligations stipulated in the contract.
- 16.3 Payments shall be made promptly by the purchaser, but in no case later than thirty (30) days after submission of an invoice or claim by the supplier.
- 16.4 Payment will be made in Rand unless otherwise stipulated.”

- (h) Only bids from **authorised dealers** will be accepted (appointment letter/contract as an authorised dealer from the official distributor or manufacturer must be submitted with the tender document). **Failure to submit this documentation with the tender document, may be seen as submitting a non-responsive bid.**
- (i) An **authorised dealer** is one who has a franchise to sell a manufacturer's product. The **authorised dealer** is usually the only **dealer** or one of a few selected **dealers** in a trading area.
- (j) Delivery must be within 30 calendar days or as agreed with the client after placement of an order, at the Municipal Stores in Schoeman Street, Mossel Bay.
- (k) Key Performance indicators

The following key performance indicators will be applicable to the successful bidder/s and will be measured after each order, to assess the performance:

- **Supplied in Terms of Specifications**

Standard	Product/Service delivered complies with specifications as set out in FWQ document.
Target	100 % achievement
Proof of evidence	Specifications according to FWQ document

- **Delivery Time Frame**

Standard	Goods and services must be delivered On-Time as agreed.
Target	100 % achievement
Proof of evidence	Delivery note

SECTION 2.1: SPECIFICATIONS

Specifications for Filter Nozzle

Filter nozzles specifications

Nozzle size: 15/16W threading

0.25 slot width

110mm stem length

Model: Ilmap – P series with screw anchor and lock nut

Lock nut: 15/16 W



P

**UGELLI A FESSURE VERTICALI
FILTER NOZZLES WITH VERTICAL SLOTS**



- Adatto per filtrazione a sabbia, antracite
- Di facile pulizia mediante controlavaggio
- Gamma completa di filetti e codoli
- Economico

- Good for sand and anthracite filters
- Easily cleaned by backwash
- Complete set of thread and stem
- Inexpensive

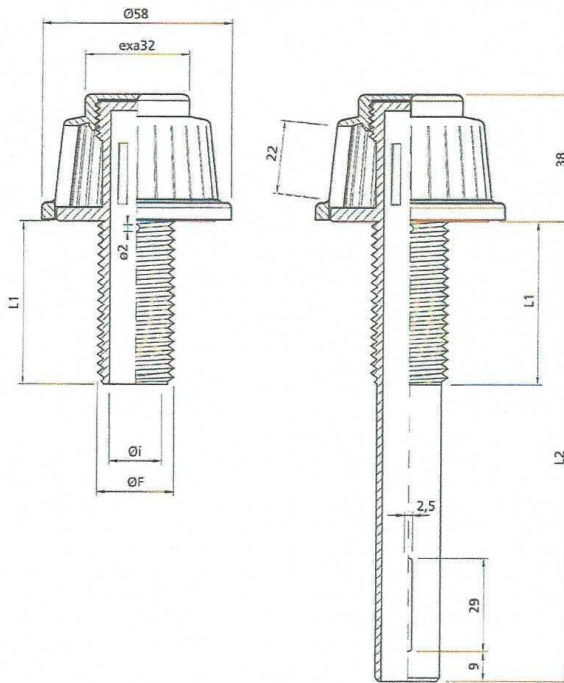

Tipo Type	Fessura Slot width mm	N. Fessure Slots No.	Sezione Area mm ²
P	0,25	30	165
	0,5	26	286
	1	20	440
	2	18	774
	3	12	684

Materiale/Material: PP - PPFV - PVDF

Filetto Thread	ØF mm	Øi mm	Area codolo Stem area mm ²	L1 mm	L2 mm
1/2"G	20,9	14,5	165	20, 50	50, 140
3/4"G	26,4	16	200	20, 30, 50	50, 80, 100, 120, 140, 160, 200, ..., 400
M20	20	14,5	165	20, 50	50, 140
M24	24	16	200	20, 30, 50	50, 80, 100, 120, 140, 160, 200, ..., 400
M30	30	16	200	30, 50	50, 160, 200, 250, 280
15/16"W	23,5	16	200	20, 30, 50, 120	50, 80, 100, 120, 140, 160, 200, ..., 400
1"W	25,4	16	200	20, 30, 50	50, 80, 100, 120, 140, 160, 200, ..., 400
1.1/4"W	31,75	21,5	363	30, 50, 65	50, 160, 200, 250, 280, 300, ..., 450

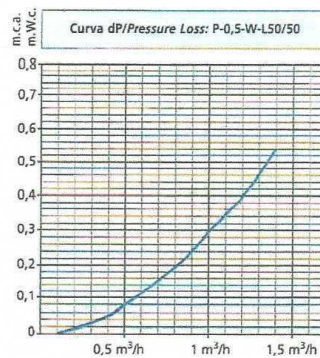
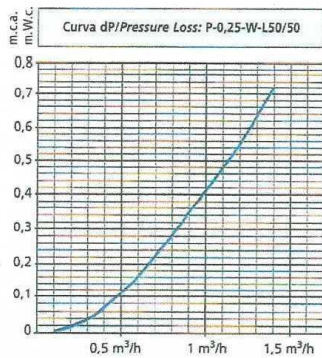

TS

TASELLI AD ESPANSIONE EXPANDING BOLTS



- Adatto per l'installazione su filtri con lato inferiore piastra portaugelli inaccessibile
- Suitable for filters where access to the underside of the nozzle plate is not possible

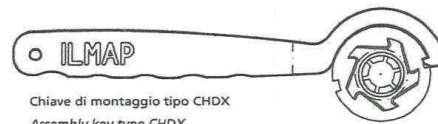
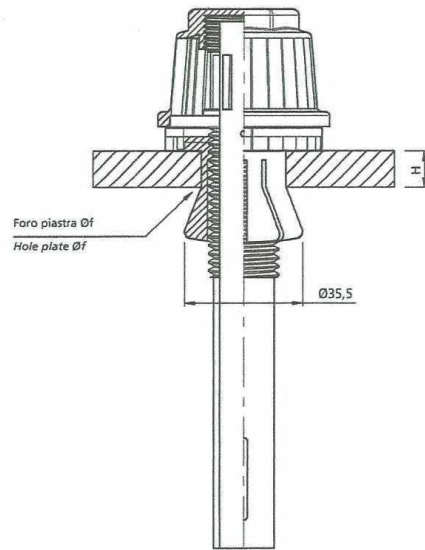
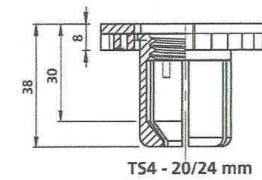
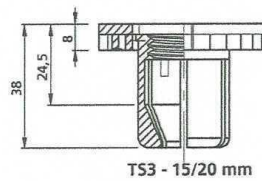
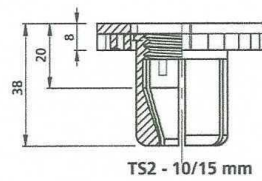
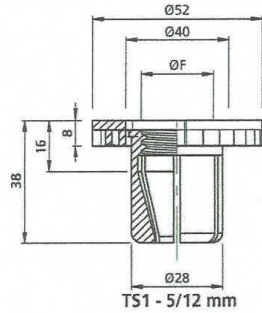

Tipo Type	Colore Colour	H Spessore piastra Plate thickness mm	Øf Diametro foro per installazione Mounting hole diameter mm	Filetto Thread
TS1	Verde Green	5 - 10	28,0 ÷ 28,5	15/16"W M24
TS2	Rosso Red	10 - 15	28,0 ÷ 28,5	
TS3	Blu Blue	15 - 20	28,0 ÷ 28,5	
TS4	Giallo Yellow	20 - 24	28,0 ÷ 28,5	

Come ordinare How to order	Tassello Expanding bolt	Ø F - Filetto Thread	Materiale Material
Esempio / Example	TS2	15/16"W	PP

Materiale / Material:	PP - PVDF
-----------------------	-----------

SECTION 2.2: PRICING SCHEDULE

Pricing Instructions mean the criteria as set out below, read together with all Parts of this contract document, which it will be assumed in the contract that the tenderer has taken into account when developing his prices.

- 2.2.1 Prices should be inclusive of VAT and all other costs to deliver the items.
- 2.2.2 The bid will be evaluated on the total amount of the contract.
- 2.2.3 Bidders are required to comply with the prescribed pricing schedule below. No pricing schedules other than the pricing schedule as stated will be accepted and **failure to adhere to this section will be seen as submitting a non-responsive bid**

ITEM NR	DESCRIPTION	QUANTITY	UNIT COST INCLUDING VAT	DELIVERY PERIOD
1	Filter Nozzels	300		

SECTION 3.1: MBD1: BID REQUIREMENTS FOR MOSSEL BAY MUNICIPALITY

PART A – INVITATION TO BID

INVITATION TO BID FOR REQUIREMENTS OF THE MOSSEL BAY MUNICIPALITY					
BID NUMBER	FWQ128/2025/2026	CLOSING DATE	6 FEBRUARY 2026	CLOSING TIME	12h00
DESCRIPTION	SUPPLY AND DELIVERY OF FILTER NOZZLES				
THE SUCCESSFUL BIDDER WILL BE REQUIRED TO FILL IN AND SIGN A WRITTEN CONTRACT FORM (MBD7)					

ORIGINAL COMPLETED BID DOCUMENTS MAY BE **POSTED** TO REACH THE TENDER BOX BY CLOSING DATE TO:

**The Tender Box
Mossel Bay Municipality
P O Box 25
MOSSEL BAY
6500**

OR

ORIGINAL COMPLETED BID DOCUMENTS MAY BE **DEPOSITED** IN THE TENDER BOX BY CLOSING DATE AT:

**The Entrance of the Mossel Bay Municipality’s Town Hall
101 Marsh Street
MOSSEL BAY**

SUPPLIER INFORMATION	
NAME OF BIDDER	
POSTAL ADDRESS AND CODE	
STREET ADDRESS	
TELEPHONE NUMBER	
ALTERNATIVE NUMBER	
E-MAIL ADDRESS	
VAT REGISTRATION NUMBER	
TAX COMPLIANCE STATUS PIN	

A B-BBEE STATUS LEVEL VERIFICATION CERTIFICATE/SWORN AFFIDAVIT (FOR EME'S & QSE'S) MUST BE SUBMITTED IN ORDER TO QUALIFY FOR PREFERENCE POINTS FOR B-BBEE)			
B-BBEE STATUS LEVEL VERIFICATION CERTIFICATE	YES	NO	
B-BBEE STATUS LEVEL SWORN AFFIDAVIT	YES	NO	
ARE YOU THE ACCREDITED REPRESENTATIVE IN SOUTH AFRICA FOR THE GOODS/SERVICES/WORK OFFERED?		YES/NO (if YES, enclose proof)	
ARE YOU'RE A FOREIGN BASED SUPPLIER FOR THE GOODS/SERVICES/WORK OFFERED?		YES/NO (if YES, answer Part B)	
TOTAL NUMBER OF ITEMS OFFERED			
TOTAL BID PRICE			
SIGNATURE OF BIDDER			
DATE			
CAPACITY UNDER WHICH THIS BID IS SIGNED			
BIDDING PROCEDURE ENQUIRIES MAY BE DIRECTED TO:		TECHNICAL ENQUIRIES MAY BE DIRECTED TO:	
DEPARTMENT	SCM	DEPARTMENT	INFRASTRUCTURE SERVICES
CONTACT PERSON	Mr. Edroy Chandler	CONTACT PERSON	Mr. Benjamin Dido
TELEPHONE NUMBER	(044) 606-5196	TELEPHONE NUMBER	(044) 606-5000 (ext.6512)
E-MAIL ADDRESS	echandler@mosselbay.gov.za	E-MAIL ADDRESS	bdido@mosselbay.gov.za

PART B – TERMS AND CONDITIONS FOR BIDDING

1. BID SUBMISSION:	
<p>1.1. BIDS MUST BE DELIVERED BY THE STIPULATED TIME TO THE CORRECT ADDRESS. LATE BIDS WILL NOT BE ACCEPTED FOR CONSIDERATION.</p> <p>1.2. ALL BIDS MUST BE SUBMITTED ON THE OFFICIAL FORMS PROVIDED – (NOT TO BE RE-TYPED) OR ONLINE</p> <p>1.3. THIS BID IS SUBJECT TO THE PREFERENTIAL PROCUREMENT POLICY FRAMEWORK ACT, THE PREFERENTIAL PROCUREMENT REGULATIONS AND ANY APPROPRIATE MUNICIPAL POLICY. THE GENERAL CONDITIONS OF CONTRACT (GCC) AND, IF APPLICABLE, ANY OTHER SPECIAL CONDITIONS OF CONTRACT.</p>	
2. TAX COMPLIANCE REQUIREMENTS	
<p>2.1 BIDDERS MUST ENSURE COMPLIANCE WITH THEIR TAX OBLIGATIONS.</p> <p>2.2 BIDDERS ARE REQUIRED TO SUBMIT THEIR UNIQUE PERSONAL IDENTIFICATION NUMBER (PIN) ISSUED BY SARS TO ENABLE THE ORGAN OF STATE TO VIEW THE TAXPAYER’S PROFILE AND TAX STATUS.</p> <p>2.3 APPLICATION FOR THE TAX COMPLIANCE STATUS (TCS) CERTIFICATE OR PIN MAY ALSO BE MADE VIA E-FILING. IN ORDER TO USE THIS PROVISION, TAXPAYERS WILL NEED TO REGISTER WITH SARS AS E-FILERS THROUGH THE WEBSITE WWW.SARS.GOV.ZA.</p> <p>2.4 FOREIGN SUPPLIERS MUST COMPLETE THE PRE-AWARD QUESTIONNAIRE IN PART B:3.</p> <p>2.5 BIDDERS MAY ALSO SUBMIT A PRINTED TCS CERTIFICATE TOGETHER WITH THE BID.</p> <p>2.6 IN BIDS WHERE CONSORTIA / JOINT VENTURES / SUB-CONTRACTORS ARE INVOLVED; EACH PARTY MUST SUBMIT A SEPARATE TCS CERTIFICATE / PIN / CSD NUMBER.</p> <p>2.7 WHERE NO TCS IS AVAILABLE BUT THE BIDDER IS REGISTERED ON THE CENTRAL SUPPLIER DATABASE (CSD), A CSD NUMBER MUST BE PROVIDED.</p>	
3. QUESTIONNAIRE TO BIDDING FOREIGN SUPPLIERS	
3.1. IS THE ENTITY A RESIDENT OF THE REPUBLIC OF SOUTH AFRICA (RSA)?	<input type="checkbox"/> YES <input type="checkbox"/> NO
3.2. DOES THE ENTITY HAVE A BRANCH IN THE RSA?	<input type="checkbox"/> YES <input type="checkbox"/> NO
3.3. DOES THE ENTITY HAVE A PERMANENT ESTABLISHMENT IN THE RSA?	<input type="checkbox"/> YES <input type="checkbox"/> NO
3.4. DOES THE ENTITY HAVE ANY SOURCE OF INCOME IN THE RSA?	<input type="checkbox"/> YES <input type="checkbox"/> NO
3.5. IS THE ENTITY LIABLE IN THE RSA FOR ANY FORM OF TAXATION?	<input type="checkbox"/> YES <input type="checkbox"/> NO
<p>IF THE ANSWER IS “NO” TO ALL OF THE ABOVE, THEN IT IS NOT A REQUIREMENT TO REGISTER FOR A TAX COMPLIANCE STATUS SYSTEM PIN CODE FROM THE SOUTH AFRICAN REVENUE SERVICE (SARS) AND IF NOT REGISTER AS PER 2.3 ABOVE.</p>	

SIGNATURE OF BIDDER:

CAPACITY UNDER WHICH THIS BID IS SIGNED:

DATE:

SECTION 4.1: MBD4: DECLARATION OF INTEREST

1. No bid will be accepted from persons in the service of the state*.
2. Any person, having a kinship with persons in the service of the state, including a blood relationship, may make an offer or offers in terms of this invitation to bid. In view of possible allegations of favoritism, should the resulting bid, or part thereof, be awarded to persons connected with or related to persons in service of the state, it is required that the bidder or their authorised representative declare their position in relation to the evaluating/adjudicating authority.
3. **In order to give effect to the above, the following questionnaire must be completed and submitted with the bid.**
4. **Bidders are required to declare any change in directorship or membership during the term of this tender should it have had an influence on the award of the bid.**

4.1	Full Name of Bidder OR his OR her representative	
4.2	Identity Number	
4.3	Position occupied in the Company (director, trustee, shareholder ²)	
4.4	Company Registration Number	
4.5	Tax Reference Number	
4.6	VAT Registration Number	
4.7 The names of all directors/trustees/shareholder's/member, their individual identity numbers and state employee numbers must be indicated in number 4, below.		
4.8 Are you presently in service of the state		YES/NO
4.8.1 If so, furnish particulars		
4.9 Have you been in the service of the state for the past twelve months?		YES/NO
4.9.1 If so, furnish particulars		
4.10 Do you have any relationship (family, friend, other) with persons in service of the state and who may be involved with the evaluation and or adjudication of this bid?		YES/NO
4.10.1 If so, furnish particulars		

4.11 Are you, aware of any relationship (family, friend, other) between a bidder and any persons in the service of the state and who may be involved with the evaluation and or adjudication of this bid?	YES/NO
4.11.1 If so, furnish particulars	
4.12 Are any of the company's directors, managers, principal shareholders or stakeholders in service of the state?	YES/NO
4.12.1 If so, furnish particulars	
4.13 Are any spouse, child or parent of the company's directors, managers, principal shareholders or stakeholders in service of the state?	YES/NO
4.13.1 If so, furnish particulars	
4.14 Do you or any of the directors, trustees, managers, principle shareholders, or stakeholders of this company have any interest in any other related companies or business whether or not they are bidding for this contract?	YES/NO
4.14.1 If so, furnish particulars	

*MSCM Regulations: "in the service of the state" means to be –

- (a) a member of –
 - (i) any municipal council;
 - (ii) any provincial legislature; or
 - (iii) the national Assembly or the national Council of provinces;
- (b) a member of the board of directors of any municipal entity;
- (c) an official of any municipality or municipal entity;
- (d) an employee of any national or provincial department, national or provincial public entity or constitutional institution within the meaning of the Public Finance Management Act, 1999 (Act No.1 of 1999);
- (e) a member of the accounting authority of any national or provincial public entity; or
- (f) an employee of Parliament or a provincial legislature.

SECTION 4.2: MBD6.1: PREFERENCE POINTS CLAIM FORM IN TERMS OF THE PREFERENTIAL PROCUREMENT REGULATIONS, 2022.

This preference form must form part of all tenders invited. It contains general information and serves as a claim form for preference points for specific goals.

NB: BEFORE COMPLETING THIS FORM, TENDERERS MUST STUDY THE GENERAL CONDITIONS, DEFINITIONS AND DIRECTIVES APPLICABLE IN RESPECT OF THE TENDER AND PREFERENTIAL PROCUREMENT REGULATIONS, 2022

1. GENERAL CONDITIONS

1.1 The following preference point systems are applicable to invitations to tender:

- the 80/20 system for requirements with a Rand value of up to R50 000 000 (all applicable taxes included); and
- the 90/10 system for requirements with a Rand value above R50 000 000 (all applicable taxes included).

1.2 To be completed by the organ of state

- (a) The 90/10 or 80/20 preference point system will be applicable in this tender. The lowest (goods and services) / highest (sales and leases) acceptable tender will be used to determine the accurate system once tenders are received.

1.3 Points for this tender (even in the case of a tender for income-generating contracts) shall be awarded for:

- (a) Price; and
- (b) Specific Goals.

1.4 To be completed by the organ of state:

The maximum points for this tender are allocated as follows:

	POINTS	POINTS
PRICE	80	90
SPECIFIC GOALS	20	10
Total points for Price and SPECIFIC GOALS	100	100

1.5 Failure on the part of a tenderer to claim points for specific goals with the tender, will be interpreted to mean that preference points for specific goals are not claimed. The tenderer is however required to submit the proof or documentation required in terms of the specific goals. That documentation may be requested by the municipality.

1.6 The organ of state reserves the right to require of a tenderer, either before a tender is adjudicated or at any time subsequently, to substantiate any claim in regard to preferences, in any manner required by the organ of state.

2. DEFINITIONS

- (a) “**tender**” means a written offer in the form determined by an organ of state in response to an invitation to provide goods or services through price quotations, competitive tendering process or any other method envisaged in legislation;
- (b) “**price**” means an amount of money tendered for goods or services, and includes all applicable taxes less all unconditional discounts;
- (c) “**rand value**” means the total estimated value of a contract in Rand, calculated at the time of bid invitation, and includes all applicable taxes;
- (d) “**tender for income-generating contracts**” means a written offer in the form determined by an organ of state in response to an invitation for the origination of income-generating contracts through any method envisaged in legislation that will result in a legal agreement between the organ of state and a third party that produces revenue for the organ of state, and includes, but is not limited to, leasing and disposal of assets and concession contracts, excluding direct sales and disposal of assets through public auctions; and
- (e) “**the Act**” means the Preferential Procurement Policy Framework Act, 2000 (Act No. 5 of 2000).

3. FORMULAE FOR PROCUREMENT OF GOODS AND SERVICES

3.1. POINTS AWARDED FOR PRICE

3.1.1 THE 80/20 OR 90/10 PREFERENCE POINT SYSTEMS

A maximum of 80 or 90 points is allocated for price on the following basis:

$$\begin{array}{ccc} \mathbf{80/20} & \mathbf{or} & \mathbf{90/10} \\ \\ \mathbf{Ps = 80 \left(1 - \frac{Pt - Pmin}{Pmin} \right)} & \mathbf{or} & \mathbf{Ps = 90 \left(1 - \frac{Pt - Pmin}{Pmin} \right)} \end{array}$$

Where

Ps = Points scored for price of tender under consideration

Pt = Price of tender under consideration

Pmin = Price of lowest acceptable tender

4. POINTS AWARDED FOR SPECIFIC GOALS

4.1. In terms of Mossel Bay Preferential Procurement Policy, preference points must be awarded for specific goals stated in the tender. For the purposes of this tender the tenderer will be allocated points based on the goals stated in table 1 below as may be supported by proof/ documentation stated in the conditions of this tender:

4.2. In cases where organs of state intend to use Regulation 3(2) of the Regulations, which states that, if it is unclear whether the 80/20 or 90/10 preference point system applies, an organ of state must, in the tender documents, stipulate in the case of—

- (a) an invitation for tender for income-generating contracts, that either the 80/20 or 90/10 preference point system will apply and that the highest acceptable tender will be used to determine the applicable preference point system; or

(b) any other invitation for tender, that either the 80/20 or 90/10 preference point system will apply and that the lowest acceptable tender will be used to determine the applicable preference point system, then the organ of state must indicate the points allocated for specific goals for both the 90/10 and 80/20 preference point system.

Table 1: Specific goals for the tender and points claimed are indicated per the table below.

(Note to organs of state: Where either the 90/10 or 80/20 preference point system is applicable, corresponding points must also be indicated as such.)

Note to tenderers: The tenderer must indicate how they claim points for each preference point system.

4.3. 50% of the 20 points will be allocated to promote this goal and points will be allocated in terms of the B-BBEE scorecard as follows.

B-BBEE Status Level of Contributor	Number of Points for Preference (80/20)	50% of Points for Preference
1	20	10
2	18	9
3	16	8
4	12	6
5	8	4
6	6	3
7	4	2
8	2	1
Non-compliant contributor	0	0

(a) A tenderer must submit proof of its B-BBEE status level contributor [scorecard].

(b) A tenderer failing to submit proof of B-BBEE status level of contributor may only score in terms of the 80-point formula for price; and scores 0 points for B-BBEE status level of contributor.

4.3.1 B-BBEE STATUS LEVEL OF CONTRIBUTOR CLAIMED IN TERMS OF PARAGRAPHS 4.1

B-BBEE Status Level of Contributor :

(Only indicate your B-BBEE Status Level of Contributor – the points will be calculated by the Municipality)

4.4. Points for specific goals to promote suppliers or service providers located in a province, district or municipal area / (hereafter referred to as locality)

(a) Each tender must specify in the invitation to tender that a maximum of 50% of the 20 points will be allocated to promote the specific goal of locality.

(b) Only one of the points as set out below that best describes the enterprise's locality may be awarded if applicable.

No	Requirement	Points for enterprises within the Mossel Bay municipal area	Points for enterprises within the Garden Route District region	Points for enterprises within the Western Cape Province and other Provinces
1	Procurement under the 80/20 preference points system where the supplier or service provider is located in:	10	6	4

(c) Bidders must submit one of the following in order to receive points for the abovementioned criterion.

- (i) Municipal Account of bidder's address as indicated in bid document;
- (ii) If the address as indicated in bid document is not in the name of the bidder, the latest lease agreement for this address or sworn affidavit from the registered owner of the property stating occupancy by the bidder is required.
- (iii) The business address of the bidder as indicated in the MBD6.1 of the bid document as the business premises should be established/leased prior to the advertisement date.
- (iv) In instances below R30 000 the address as specified within the Central Supplier Database will be utilized for identification of the specific goal and the points will automatically be added to the preference point system. The Municipality however reserves the right to also request supporting evidence.
- (v) Only fully operational business premises will be accepted. All vacant erven, storage units and postal addresses do not qualify as a business premises.

4.4.1 LOCALITY CLAIMED IN TERMS OF PARAGRAPHS 4.4

Locality (indicate as per table above) :

(The address provided in 4.5 below, will be used to determine the locality as per 4.4 above)

4.5. MUNICIPAL INFORMATION

Municipality where business is situated :

Registered Account Number :

Stand Number :

DECLARATION WITH REGARD TO COMPANY/FIRM

4.6. Name of company/firm.....

4.7. Company registration number:

4.8. TYPE OF COMPANY/ FIRM

- Partnership/Joint Venture / Consortium
- One-person business/sole propriety
- Close corporation
- Public Company
- Personal Liability Company
- (Pty) Limited
- Non-Profit Company
- State Owned Company

[TICK APPLICABLE BOX]

4.9. I, the undersigned, who is duly authorised to do so on behalf of the company/firm, certify that the points claimed, based on the specific goals as advised in the tender, qualifies the company/ firm for the preference(s) shown and I acknowledge that:

- i) The information furnished is true and correct;
- ii) The preference points claimed are in accordance with the General Conditions as indicated in paragraph 1 of this form;
- iii) In the event of a contract being awarded as a result of points claimed as shown in paragraphs 1.4 and 4.2, the contractor may be required to furnish documentary proof to the satisfaction of the organ of state that the claims are correct;
- iv) If the specific goals have been claimed or obtained on a fraudulent basis or any of the conditions of contract have not been fulfilled, the organ of state may, in addition to any other remedy it may have –
 - (a) disqualify the person from the tendering process;
 - (b) recover costs, losses or damages it has incurred or suffered as a result of that person’s conduct;
 - (c) cancel the contract and claim any damages which it has suffered as a result of having to make less favourable arrangements due to such cancellation;
 - (d) recommend that the tenderer or contractor, its shareholders and directors, or only the shareholders and directors who acted on a fraudulent basis, be restricted from obtaining business from any organ of state for a period not exceeding 10 years, after the *audi alteram partem* (hear the other side) rule has been applied; and
 - (e) forward the matter for criminal prosecution, if deemed necessary.

WITNESSES	
1.
2.

.....	
SIGNATURE(S) OF BIDDERS(S)	
DATE:
ADDRESS:

SECTION 4.3: MUNICIPAL RATES AND TAXES

Names of Directors/Partners/Senior Managers	Physical residential address of the Directors/Partners/Senior Managers	Residential Municipal Account number(s)	Name of Municipality

*Documentation as indicated in Section 1.2.8.2 must be submitted with the tender document.

DECLARATION

I, THE UNDERSIGNED (NAME and SURNAME)

CERTIFY THAT THE INFORMATION FURNISHED ABOVE IS CORRECT. I ACCEPT THAT THE STATE MAY ACT AGAINST ME SHOULD THIS DECLARATION PROVE TO BE FALSE.

.....
Signature

.....
Date

.....
Position

.....
Name of Bidder

SECTION 4.4: AUTHORITY FOR SIGNATORY

We, the undersigned, hereby authorize Mr/Mrs.....
acting in his/her capacity as
of the business trading as
to sign all documentation in connection with

NAME OF MEMBERS/DIRECTORS	SIGNATURE	DATE

Note: If bidders attach a copy of their Authorised Signatory as per Section 1.2.9 of the tender document, it is not necessary to complete this form.

“If a bidder is a sole proprietor, it is not required to complete this form, provided that the tender document was completed and signed by the owner”

SECTION 4.5: MBD8: DECLARATION OF BIDDER'S PAST SUPPLY CHAIN MANAGEMENT PRACTICES

1. This Municipal Bidding Document must form part of all bids invited.
2. It serves as a declaration to be used by municipalities and municipal entities in ensuring that when goods and services are being procured, all reasonable steps are taken to combat the abuse of the supply chain management system.
3. The bid of any bidder may be rejected if that bidder, or any of its directors have:
 - a. abused the municipality's / municipal entity's supply chain management system or committed any improper conduct in relation to such system;
 - b. been convicted for fraud or corruption during the past five years;
 - c. wilfully neglected, reneged on or failed to comply with any government, municipal or other public sector contract during the past five years; or
 - d. been listed in the Register for Tender Defaulters in terms of section 29 of the Prevention and Combating of Corrupt Activities Act (No 12 of 2004).
4. In order to give effect to the above, the following questionnaire must be completed and submitted with the bid.

Item	Question	Yes	No
4.1	<p>Is the bidder or any of its directors listed on the National Treasury's database as a company or person prohibited from doing business with the public sector?</p> <p>(Companies or persons who are listed on this database were informed in writing of this restriction by the National Treasury after the audi alteram partem rule was applied).</p> <p>The Database of Restricted Suppliers now resides on the National Treasury's website(www.treasury.gov.za) and can be accessed by clicking on its link at the bottom of the home page.</p>	<p>Yes</p> <p><input type="checkbox"/></p>	<p>No</p> <p><input type="checkbox"/></p>
4.1.1	If so, furnish particulars:		
4.2	<p>Is the bidder or any of its directors listed on the Register for Tender Defaulters in terms of section 29 of the Prevention and Combating of Corrupt Activities Act (No 12 of 2004)?</p> <p>The Register Tender Defaulters can be accessed on the National Treasury's website (www.treasury.gov.za) by clicking on its link at the bottom of the home page.</p>	<p>Yes</p> <p><input type="checkbox"/></p>	<p>No</p> <p><input type="checkbox"/></p>
4.2.1	If so, furnish particulars:		

4.3	Was the bidder or any of its directors convicted by a court of law (including a court of law outside the Republic of South Africa) for fraud or corruption during the past five years?	Yes <input type="checkbox"/>	No <input type="checkbox"/>
4.3.1	If so, furnish particulars:		
4.4	Does the bidder or any of its directors owe any municipal rates and taxes or municipal charges to the municipality / municipal entity, or to any other municipality / municipal entity, that is in arrears for more than three months?	Yes <input type="checkbox"/>	No <input type="checkbox"/>
4.4.1	If so, furnish particulars:		
4.5	Was any contract between the bidder and the municipality / municipal entity or any other organ of state terminated during the past five years on account of failure to perform on or comply with the contract?	Yes <input type="checkbox"/>	No <input type="checkbox"/>
4.5.1	If so, furnish particulars:		

CERTIFICATION

I, THE UNDERSIGNED (FULL NAME)CERTIFY THAT THE INFORMATION FURNISHED ON THIS DECLARATION FORM TRUE AND CORRECT.

I ACCEPT THAT, IN ADDITION TO CANCELLATION OF A CONTRACT, ACTION MAY BE TAKEN AGAINST ME SHOULD THIS DECLARATION PROVE TO BE FALSE.

.....
Signature

.....
Date

.....
Position

.....
Name of Bidder

SECTION 4.6: MBD9: CERTIFICATE OF INDEPENDENT BID DETERMINATION

1. This Municipal Bidding Document (MBD) must form part of all bids¹ invited.
2. Section 4 (1) (b) (iii) of the Competition Act No. 89 of 1998, as amended, prohibits an agreement between, or concerted practice by, firms, or a decision by an association of firms, if it is between parties in a horizontal relationship and if it involves collusive bidding (or bid rigging). ² Collusive bidding is a *pe se* prohibition meaning that it cannot be justified under any grounds.
3. Municipal Supply Regulation 38 (1) prescribes that a supply chain management policy must provide measures for the combating of abuse of the supply chain management system, and must enable the accounting officer, among others, to:
 - a. take all reasonable steps to prevent such abuse;
 - b. reject the bid of any bidder if that bidder or any of its directors has abused the supply chain management system of the municipality or municipal entity or has committed any improper conduct in relation to such system; and
 - c. cancel a contract awarded to a person if the person committed any corrupt or fraudulent act during the bidding process or the execution of the contract.
4. This MBD serves as a certificate of declaration that would be used by institutions to ensure that, when bids are considered, reasonable steps are taken to prevent any form of bid-rigging.
5. In order to give effect to the above, the attached Certificate of Bid Determination (MBD9) must be completed and submitted with the bid:

¹ Includes price quotations, advertised competitive bids, limited bids and proposals.

² Bid rigging (or collusive bidding) occurs when businesses, that would otherwise be expected to compete, secretly conspire to raise prices or lower the quality of goods and / or services for purchasers who wish to acquire goods and / or services through a bidding process. Bid rigging is, therefore, an agreement between competitors not to compete.

CERTIFICATE OF INDEPENDENT BID DETERMINATION

I, the undersigned, in submitting the accompanying bid:

FWQ128/2025/2026: SUPPLY AND DELIVERY OF FILTER NOZZLES

(Bid Number and Description)

in response to the invitation for the bid made by:

MOSSEL BAY

(Name of Municipality / Municipal Entity)

do hereby make the following statements that I certify to be true and complete in every respect:

I certify, on behalf of: _____ that:

(Name of Bidder)

1. I have read and I understand the contents of this Certificate;
2. I understand that the accompanying bid will be disqualified if this Certificate is found not to be true and complete in every respect;
3. I am authorized by the bidder to sign this Certificate, and to submit the accompanying bid, on behalf of the bidder;
4. Each person whose signature appears on the accompanying bid has been authorized by the bidder to determine the terms of, and to sign, the bid, on behalf of the bidder;
5. For the purposes of this Certificate and the accompanying bid, I understand that the word "competitor" shall include any individual or organization, other than the bidder, whether or not affiliated with the bidder, who:
 - (a) has been requested to submit a bid in response to this bid invitation;
 - (b) could potentially submit a bid in response to this bid invitation, based on their qualifications, abilities or experience; and
 - (c) provides the same goods and services as the bidder and/or is in the same line of business as the bidder
6. The bidder has arrived at the accompanying bid independently from, and without consultation, communication, agreement or arrangement with any competitor. However, communication between partners in a joint venture or consortium³ will not be construed as collusive bidding.
7. In particular, without limiting the generality of paragraphs 6 above, there has been no consultation, communication, agreement or arrangement with any competitor regarding:

- (a) prices;
- (b) geographical area where product or service will be rendered (market allocation)
- (c) methods, factors or formulas used to calculate prices;
- (d) the intention or decision to submit or not to submit, a bid;
- (e) the submission of a bid which does not meet the specifications and conditions of the bid; or
- (f) bidding with the intention not to win the bid.

8. In addition, there have been no consultations, communications, agreements or arrangements with any competitor regarding the quality, quantity, specifications and conditions or delivery particulars of the products or services to which this bid invitation relates.
9. The terms of the accompanying bid have not been, and will not be, disclosed by the bidder, directly or indirectly, to any competitor, prior to the date and time of the official bid opening or of the awarding of the contract.
10. I am aware that, in addition and without prejudice to any other remedy provided to combat any restrictive practices related to bids and contracts, bids that are suspicious will be reported to the Competition Commission for investigation and possible imposition of administrative penalties in terms of section 59 of the Competition Act No. 89 of 1998 and or may be reported to the National Prosecuting Authority (NPA) for criminal investigation and or may be restricted from conducting business with the public sector for a period not exceeding ten (10) years in terms of the Prevention and Combating of Corrupt Activities Act No. 12 of 2004 or any other applicable legislation.

.....
Signature

.....
Date

.....
Position

.....
Name of Bidder

³ Joint venture or Consortium means an association of persons for the purpose of combining their expertise, property, capital, efforts, skill and knowledge in an activity for the execution of a contract.

SECTION 5: DECLARATION

1. I hereby declare that I have read, understood, agree and comply with all of the sections below, if included, that it shall be deemed to form and be construed as part of this agreement:

- (i) Bidding documents, viz
 - Invitation to bid;
 - Tax Compliance Status Pin;
 - Pricing schedule(s);
 - Technical Specification(s);
 - Preference claims for Broad Based Black Economic Empowerment Status Level of Contribution in terms of the Preferential Procurement Regulations,
 - Points claims in terms of specific goals for locality;
 - Declaration of interest;
 - Declaration of bidder's past SCM practices;
 - Certificate of Independent Bid Determination
 - Special Conditions of Contract;
- (ii) General Conditions of Contract; and
- (iii) Other (specify)

2. I confirm that I am duly authorised to sign this document.

NAME (PRINT)

CAPACITY

SIGNATURE

NAME OF FIRM

DATE

WITNESSES	
1.
2.
DATE:

SECTION 6.1: MBD7.1: CONTRACT FORM: PART 1 (TO BE COMPLETED BY THE BIDDER)

BOTH THE SERVICE PROVIDER/SUPPLIER (PART 1) AND THE PURCHASER/LESSEE (PART 2) MUST FILL THIS FORM IN DUPLICATE. BOTH FORMS MUST BE SIGNED IN THE ORIGINAL SO THAT THE SERVICE PROVIDER/SUPPLIER AND THE PURCHASER/LESSEE WOULD BE IN POSSESSION OF ORIGINALLY SIGNED CONTRACTS FOR THEIR RESPECTIVE RECORDS.

1. The following documents shall be deemed to form and be read and construed as part of this agreement:

- (i) Bidding documents, viz
 - Invitation to bid;
 - Tax Compliance Status Pin;
 - Pricing schedule(s);
 - Technical Specification(s);
 - Preference claims for Broad Based Black Economic Empowerment Status Level of Contribution in terms of the Preferential Procurement Regulations,
 - Points claims in terms of specific goals for locality;
 - Declaration of interest;
 - Declaration of bidder's past SCM practices;
 - Certificate of Independent Bid Determination
 - Special Conditions of Contract;
- (ii) General Conditions of Contract; and
- (iii) Other (specify)

2. I confirm that I have satisfied myself as to the correctness and validity of my bid; that the price(s) and rate(s) quoted cover all the goods and/or works specified in the bidding documents; that the price(s) and rate(s) cover all my obligations and I accept that any mistakes regarding price(s) and rate(s) and calculations will be at my own risk.

I accept full responsibility for the proper execution and fulfilment of all obligations and conditions devolving on me under this agreement as the principal liable for the due fulfilment of this contract.

3. I declare that I have no participation in any collusive practices with any bidder or any other person regarding this or any other bid.

4. I confirm that I am duly authorised to sign this contract.

NAME (PRINT)

CAPACITY

SIGNATURE

NAME OF FIRM

DATE

WITNESSES	
1.
2.
DATE:

SECTION 6.2: MBD7.2: CONTRACT FORM: PART 1 (TO BE COMPLETED BY THE PURCHASER)

1. I..... in my capacity as Director: Infrastructure Services accept your bid under reference number FWQ128/2025/2026 dated..... for the supply of goods/works indicated hereunder and/or further specified in the annexure(s).
2. An official order indicating delivery instructions is forthcoming.
3. I undertake to make payment for the goods/works delivered in accordance with the terms and conditions of the contract, within 30 (thirty) days after receipt of an invoice accompanied by the delivery note.

ITEM NO	PRICE (ALL APPLICABLE TAXES INCLUDED)	BRAND	DELIVERY PERIOD	B-BBEE STATUS LEVEL OF CONTRIBUTION	LOCALITY

4. I confirm that I am duly authorized to sign this contract.

SIGNED AT MOSEL BAY ON.....

NAME AND SURNAME (PRINT)

SIGNATURE

OFFICIAL STAMP

WITNESSES

1.

2.

DATE: